



INSTRUCTIONS FOR USE

Dopplex[®] Ability

Dopplex[®] Ability Auto ABI Monitor





Dopplex Ability - English

Table of Contents

1. Safety	4
1.1 Warnings.....	4
1.2 Residual Risks	4
1.3 Patient Applied Parts	4
1.4 Service Life.....	4
2. Infection Control	5
3. Intended Use	5
3.1 User Requirements	5
4. Limitations of Use / Contraindications	6
4.1 Model Description.....	6
5. Preliminary Checks	7
6. Initial Set-up	8
6.1 Battery Re-Connection *.....	8
6.2 Setting the Language	9
6.3 Battery Conditioning *	9
7. Use Environment	10
8. Line (Mains) Power Operation	10
8.1 Fuses.....	10
9. Battery Operation *	11
10. Product Identification	12
10.1 Front Panel	12
10.2 Rear Panel	12
10.3 Base	13
10.4 Product Labelling.....	13
11. System Connection	15
11.1 USB Port	15
12. Operation	16
12.1 Getting Started	16
12.2 Loading Paper *.....	17
12.3 User Settings.....	17
12.3.1 System Settings	17
12.4 Making a Measurement	20
12.4.1 Patient Preparation.....	20





- 12.4.2 Setting Patient Type 21
- 12.4.3 Fitting the Cuffs 21
- 12.4.4 Performing the test 24
- 12.4.5 Viewing the results 25
- 12.4.6 Example reports 26
- 12.4.7 Paper Low Indication * 26
- 12.4.8 Report Storage Guidance * 26
- 12.5 Switching the Unit into Standby 26**
- 13. Troubleshooting 27**
- 13.1 Error Messages 27
- 13.2 Cuff Leak Test 29
- 13.3 Guidance for Reliable Performance 30
- 14. Care and Cleaning 31**
- 14.1 General Care 31
- 14.2 Cleaning and Disinfecting Cuffs and Tubing 31
- 14.3 Cleaning and Disinfecting the Ability Unit 32
- 15. Maintenance 32**
- 16. Accessories 33**
- 16.1 Carry bag 33
- 16.2 Roll Stand 34
- 17. Specifications 36**
- 17.1 Equipment Classification 36
- 17.2 Performance 36
- 17.3 General 36
- 17.4 Environmental 37
- 17.5 Standards Compliance 37
- 17.6 Batteries 37
- 17.7 Accessories 38
- 18. Electromagnetic Compatibility 39**
- 18.1 Electrostatic Discharge 41
- 19. End of Life Disposal 42**
- 20. Warranty & Service 42**

Note

As our policy is one of continuous improvement, we reserve the right to modify designs without prior notice.



1. Safety



Before using this equipment, please study this manual carefully and familiarise yourself with the controls, display features and operation. Ensure that each user fully understands the safety and operation of the unit, as mis-use may cause harm to the user or patient, or damage to the product.

Please keep these Instructions for Use to hand for future reference.

Symbols



WARNING:

Indicates the possibility of death or serious injury

CAUTION:

Indicates the possibility of personal injury or material damage.



Attention, consult accompanying documents / Instructions for Use

1.1 Warnings



- A possible explosion hazard exists if used in the presence of flammable anaesthetics.
- Do not operate the unit from the mains supply if the mains cable is damaged.
- Do not immerse any portion of the unit in water or other liquids.
- If this product is connected to another item of electrical equipment, it is important that the system is fully compliant with IEC60601-1:2012.
- Do not apply cuff directly to non-intact skin. If a wound is present, ensure a suitable wound dressing is applied, followed by an infection control barrier sleeve.
- When configuring the system, consider and minimise the risk of persons tripping over the tubing and electrical cables.
- This equipment must not be modified.

1.2 Residual Risks

Residual risks are those risks that require a warning or caution to be entered into this manual. They are identified by the proximity of this symbol.



1.3 Patient Applied Parts

As defined in IEC60601-1:2012, the patient applied parts of the dopplex Ability are the four dual chamber cuffs.

1.4 Service Life

This has been defined as the minimum time period during which the device is expected to remain safe and suitable to meet its intended use, and all risk control measures remain effective. Huntleigh Healthcare Ltd's commitment is that the expected service life for this Device has been defined as 7 years.



2. Infection Control



WARNING: Before fitting cuffs to the patient, evaluate the cross contamination risk. For medium/high risk situations, where the patient has a known infection or skin is not intact, use an infection control barrier sleeve with aseptic technique.

Infection control barrier sleeves are available as an accessory, Part No. ACC-VAS-016.

Refer to Section 12.4 for sleeve and cuff fitting instructions.

Refer to Section 14.2 for care and cleaning instructions.



WARNING: Infection control barrier sleeves are single use devices and must not be re-used. They must be disposed of as infectious clinical waste.

3. Intended Use

It is intended to be used on all patients considered to be at risk of having, or developing peripheral arterial disease (PAD).

Dopplex Ability is intended for the rapid measurement of ankle-brachial pressure index (ABPI) or ankle-brachial index (ABI) in adults and pulse volume recording (PVR) / volume plethysmography.

Ability is suitable for use in woundcare assessment, for assessing symptomatic PAD, and as a screening device for PAD.

It may also be used on patients with venous or arterial ulcers prior to the application of compression therapy.

Dopplex Ability can be used on patients with unilateral lower limb amputation.

3.1 User Requirements

Dopplex Ability is intended for use only by a suitably qualified healthcare professional. If an ABI test is undertaken by a Healthcare Support Worker, then patient selection and assessment of results must be performed by a qualified clinician in conjunction with a clinical assessment.

It is recommended that all users familiarise themselves with the information provided in this user manual before using this product.



4. Limitations of Use / Contraindications



WARNING: Dopplex Ability is not intended to be used in the following patient conditions:

- a suspected or present Deep Vein Thrombosis (DVT)
- severe congestive cardiac failure or similar condition
- gangrene
- recent skin graft
- untreated leg or foot wounds
- dermatitis



WARNING: Systolic pressures are displayed for information only, and should not be used to form a clinical diagnosis.

CAUTION: Dopplex Ability is not intended to be used in the following patient conditions:

- cellulitis
- management of pulmonary hypertension
- patients who cannot remain still or lie flat
- patients under 18 years of age
- Severe hypertension
- Parkinsons Disease
- Severe PAD (ankle systolic pressure less than 60 mmHg)
- Lymphoedema
- Very oedematous limbs
- Any condition that prevents both arm pressures being measured e.g. mastectomy

CAUTION

- Dopplex Ability provides just one indicator of vascular condition. This should be used as part of an holistic approach to leg ulcer assessment together with other factors in forming the clinical diagnosis. The results from dopplex Ability must not be solely relied upon. A complete vascular assessment including clinical history and symptoms must be made before taking appropriate action.
- If the results from the dopplex Ability do not match the clinical history and symptoms of the patient, then further tests, e.g. Doppler waveform analysis, are recommended.
- False high ABI results may occur in diabetic patients when the leg cuff is unable to compress calcified distal arteries on the ankle effectively.
- Ensure all cuffs are fitted correctly and aligned on limbs according to the instructions. Measurement error may occur if cuffs are fitted incorrectly.
- The ABI Classification thresholds, which are adjustable via the front panel function buttons, should only be adjusted by a suitably qualified clinician.
- Always observe ABI value, not only classification, as marginal results could be overlooked.
- Do not sterilise the product or its accessories. The product will be damaged, and there is a risk of patient and user harm.
- If using the dopplex Ability roll stand, ensure the unit is properly locked in place, otherwise it could fall, and cause personal injury. age.

4.1 Model Description

REF	Product Features
DA100	Dopplex Ability
DA100P	Dopplex Ability with integral printer
DA100PB	Dopplex Ability with integral printer and battery



5. Preliminary Checks

Contents (supplied with each system)

Item	Item	Item
1 x dopplex Ability	Allen Key	Instructions for Use, Quick Reference Guide, FAQ's, * PVR Application, *
4 x Adult Dual Chamber Cuffs with Colour Coded tubes	2 x Rolls Printer Paper* (1 x plain, 1 x label)	
1 x Box Infection Control Barrier Sleeves	1 x Mains Cable	

* www.huntleigh-diagnostics.com

Delivery Inspection

Huntleigh Healthcare Ltd takes every precaution to ensure that goods reach you in perfect condition. However, accidental damage can occur in transit and storage. For this reason we recommend that a thorough visual inspection is made immediately the unit is received. Should any damage be evident or any parts missing, ensure that Huntleigh Healthcare Ltd is informed as soon as possible.

Storage

Should the unit not be required for immediate use, it should be re-sealed into its original packing after carrying out the initial delivery inspection, and stored under covered conditions at a temperature between -20°C to +50°C, and relative humidity of 10% to 90% non-condensing.

If it is necessary to store the unit after a period of use, it is advisable to first disconnect the battery* (remove battery cover as described below and disconnect battery – DO NOT APPLY STRAIN TO THE WIRES), and remove pressure from the printer roller by opening the printer lid slightly. Then follow the above storage instructions.

Note

- Expected battery lifetime depends on care. With correct care, frequent charging and storage at room temperature, the battery life can be prolonged.
- If the unit is stored in high ambient temperatures and/or for an extended period without re-charging, it is likely that battery capacity will be degraded.
- Replace the battery every two years.

For long term storage, the internal Real Time Clock backup battery should also be removed. Refer to the service manual for details.

* Depending on model



6. Initial Set-up

6.1 Battery Re-Connection *

Note

The dopplex Ability is supplied with the internal battery disconnected. To re-connect the battery, please see instructions below.

1. Invert the unit and remove the battery cover by removing the securing screw using the allen key provided.

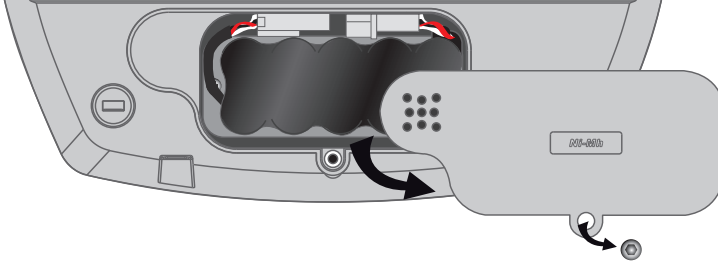

2. Lift the battery out, and connect the battery to the unit.

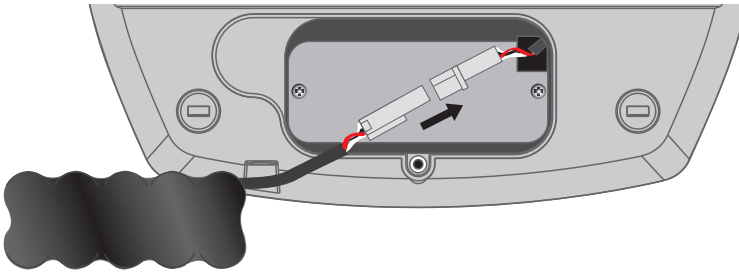

3. Replace the battery. Re-fit the battery cover and replace the securing screw with the allen key provided. **DO NOT OVERTIGHTEN!**

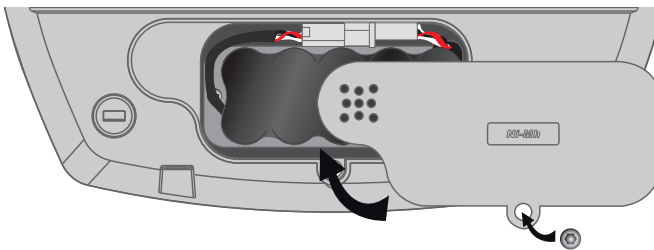

* Depending on model



4. Connect the unit to the mains supply (1) and switch it on by pressing the On/Standby button (2).

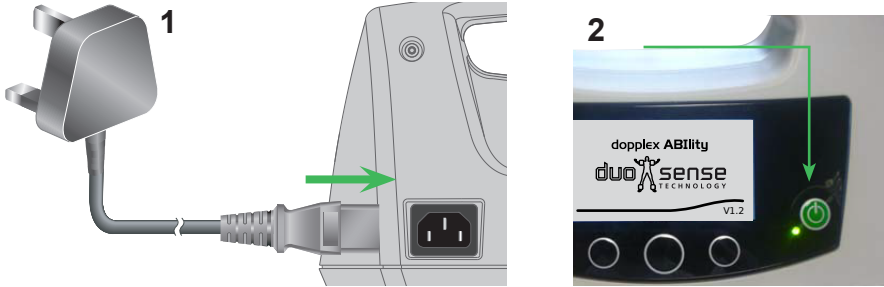

6.2 Setting the Language

When switched on for the first time, the operating language must be selected.

The language selection screen will be displayed.

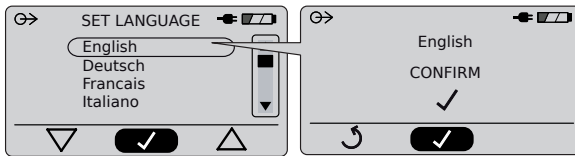

Press to highlight the required language. Press to Select.

6.3 Battery Conditioning *

Immediately after the language has been selected, the battery conditioning screen will be displayed.

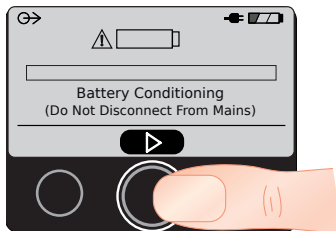

Note: The battery must be conditioned before the unit is first used. If the battery is not conditioned, battery operation will be unreliable.

To start battery conditioning, press the centre softkey.

When conditioning is complete, the unit will switch off automatically. It can then be switched on and used from mains supply or battery.

Note: Battery conditioning can take up to 10 hours to complete.

** Depending on model*



7. Use Environment

Dopplex Ability is suitable for use in hospital, primary care and community settings. It must not be used outdoors, or in any environment where it may come into contact with water.

This equipment is not suitable for domestic use.

A couch, or similar level support surface is required for the patient to lie on, and the main unit requires a table or similar for support. Alternatively, a roll stand is available as an accessory, part number ACC-VAS-013.



WARNING: It is important for safety that the use environment is well-lit to reduce the risk of persons tripping over the cables and tubes. Use is not recommended in areas that are used as access walkways.

Use in strong sunlight should be avoided as display visibility is greatly reduced.

The patient support surface must be wide enough for the patient to be able to allow their arms to lie comfortably at their sides. The patient's arms must be completely relaxed during the test and not pulled tight against the body. The couch should be separated from adjacent walls etc. as pressure on the arms or cuffs must be avoided. The patient's heels must be supported on the couch and not be allowed to overhang the end. The test environment should be reasonably quiet, as excessive ambient noise may prevent the patient from relaxing; an important test requirement.

8. Line (Mains) Power Operation

Dopplex Ability is supplied with a plug-in mains lead, fitted with a 3 pin mains plug. The cores use the European colour code :

BROWN	LIVE
BLUE	NEUTRAL
GREEN/YELLOW	FUNCTIONAL EARTH

If it becomes necessary to fit a new mains plug take care that the wires have correct lengths, so that in the event of extreme strain, the earth wire will be the last to break. Make sure that the cable clamp secures the outer sheathing so that there is no direct strain on any individual wires at the terminals. Where the plug is fused, a 5A fuse should be fitted.

Connect the power cable to the line power socket. If a good, reliable earth is not available operate the dopplex Ability from its internal battery pack *.

Note: To isolate the dopplex Ability from the mains or line supply, disconnect the power cable from the mains inlet at the rear of the unit. Ensure this is fully accessible at all times.

** Depending on model*

8.1 Fuses

Internal fuses are fitted in both the live and neutral lines. Correctly rated fuses must be fitted as below:-

T1AH 250VAC

Fuses must only be replaced by a suitably qualified technician.



9. Battery Operation *

The internal battery, when fully charged, provides enough power for approximately ten ABI measurements.

An on-screen indicator shows the state of charge at all times.

Battery charging takes place when the unit is connected to the line (mains) power. During battery charging, the battery symbol fills from left to right. The time required to fully charge a completely discharged battery is approximately two hours.

When the battery reaches a critically low level of charge such that further use is not possible, the battery symbol will appear in outline, and will flash continuously. The unit will then switch off automatically when the battery is completely discharged.

If the battery is disconnected for any reason, it must be conditioned immediately after re-connection. Refer to section 12.3.1 (h) for instructions. Failure to do this will result in unreliable operation from the battery.

Power Save Functions

When operated from the internal battery, power save functions are enabled:

- After three minutes of no keypad use, the display backlight will switch off. To switch backlight back on, simply press any of the buttons below the display once.
- After ten minutes of no keypad use, the unit will switch off. To switch the unit back on, press the power On/Standby button and hold for three seconds.

Note: Any results will be lost unless a printout has been produced.

** Depending on model*



10. Product Identification

10.1 Front Panel

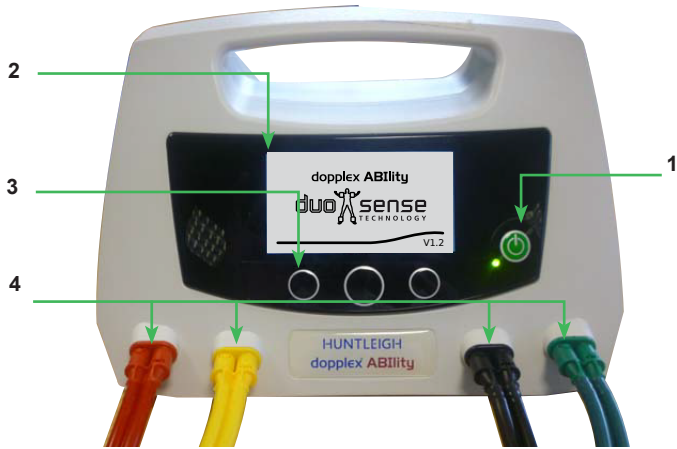

1	On/Standby button
2	Display
3	Function Buttons
4	Colour Coded Tubes

10.2 Rear Panel

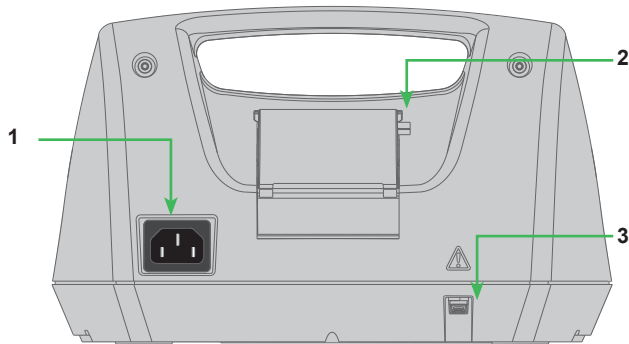

1	Mains Inlet
2	Printer Cover (depending on model)
3	COM Port Connector (USB)



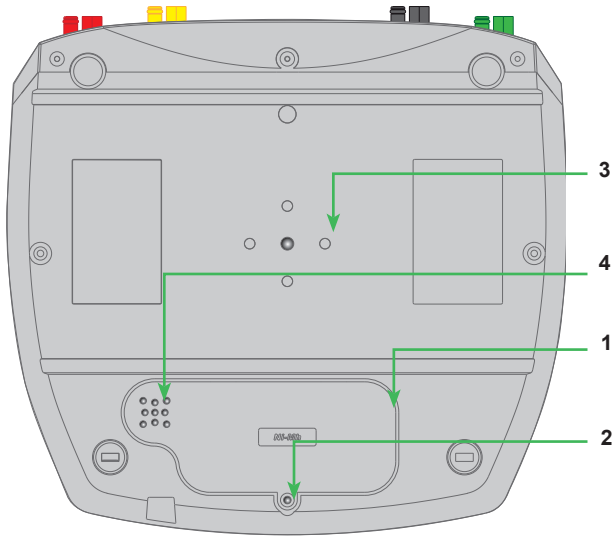





















10.3 Base



1	Battery Cover
2	Battery Cover Retaining Screw
3	Slide plate Mounting boss
4	Air Filter

10.4 Product Labelling

Note: Product labelling should be read from a distance no greater than 0.5m.			
	Dopplex Ability is Class II, double insulated according to the definitions in IEC60601-1:2012		
	Applied parts (cuffs) are type BF according to the definitions in IEC60601-1:2012		
	Functional Earth		Power On/Standby
	Alternating current (AC)		
	This symbol signifies that this product, including its accessories and consumables is subject to the WEEE (Waste Electrical and Electronic Equipment) regulations and should be disposed of responsibly in accordance with local procedures.		
	This symbol signifies that this product complies with the essential requirements of the Medical Device Directive (93/42/EEC) - Medical Device Regulation (EU/2017/745)		

 	<p>WARNING: Indicates the possibility of death or serious injury</p> <p>CAUTION: Indicates the possibility of personal injury or material damage.</p> <p>Attention, consult accompanying documents / Instructions for Use</p>		
	<p>Legal Manufacturer in association with the CE mark in Europe ArjoHuntleigh AB, Hans Michelsensgatan 10 211 20 Malmö, Sweden</p>		
<p>Manufactured By:</p>	<p>Huntleigh Healthcare Ltd. 35 Portmanmoor Road, Cardiff, CF24 5HN, United Kingdom T: +44 (0)29 20485885 sales@huntleigh-diagnostics.co.uk www.huntleigh-diagnostics.com</p>		
<p>ANSI/AAMI ES60601-1 (2012, 3.1 ed.) CAN/CSA-C22.2 No 60601-1 (2014) UL60601-1, CAN/CSA C22.2 No 601.1</p>  <p>Medical Electrical Equipment E364062</p>	<p>The UL mark indicates that Dopplex Ability complies with Underwriters Laboratories requirements for safety, and is subject to UL's follow up services program which verifies that the manufactured product continues to comply with UL's safety requirements.</p>		
 <p>YYYY-MM</p>	<p>Use By</p>		<p>Do Not Reuse</p>
 <p>-10°C</p>	<p>Temperature Limitations</p>	 <p>25°C</p>	<p>Upper Limit of Temperature</p>
	<p>Serial Number</p>		<p>Reference Number</p>
	<p>Medical Device</p>		<p>Device Identifier</p>
	<p>Keep Dry</p>		<p>Do not use hook</p>
	<p>This way up</p>		<p>Contents can be recycled</p>
	<p>Returnable packaging</p>		<p>Cardboard packaging can be recycled.</p>
	<p>PVC FREE Does not contain PVC</p>		<p>LATEX FREE Does not contain Latex</p>
 <p>95%</p>	<p>Limits of Relative Humidity</p>		<p>Limits of Atmospheric Pressure</p>
	<p>Fragile</p>		<p>Date of Manufacture</p>
	<p>RoHS Compliant (RoHS - Restriction of Hazardous Substances)</p>	<p>IP30</p>	<p>Protected against ingress of solid foreign objects >2.5mm diameter. Not protected against ingress of water.</p>



11. System Connection



WARNING: These requirements must be met when a dopplex Ability is connected to any other electrical equipment, such as a PC.

- 1 Non-medical equipment must comply with the relevant IEC or ISO safety standard. For Information Technology equipment, this standard is IEC62368.
- 2 Medical equipment must comply with IEC60601-1, or equivalent.
- 3 The configured system must comply with the requirements of IEC60601-1:2012; clause 16.
- 4 If non-medical equipment (e.g. the PC or printer) with enclosure leakage currents greater than those allowed by IEC60601-1 is to be used in the patient environment (within 1.5m of the patient), the enclosure leakage currents must be brought within the limits laid down by IEC60601-1. This may be achieved by using a medical grade isolating transformer. Suitable types are available via Huntleigh sales agents.
- 5 Anyone who connects additional equipment to signal input or signal output parts of the system is configuring a medical system, and is therefore responsible for ensuring that the system complies with the requirements of IEC60601-1:2012; clause 16. If there is any doubt as to whether your system complies, consult the technical service department or your local Huntleigh representative.

11.1 USB Port

Dopplex Ability is fitted with a standard USB port (see item 3, section 10.2 'Rear Panel') for connection to a personal computer (PC).

Connections to this port should only be made by suitably technically qualified personnel. For technical specifications of this interface, refer to section 16.3.

It is intended to be used for software upgrade purposes, and has no functionality in normal use.

For further information, contact the service department at the address given in section 18 of this manual.



12. Operation

12.1 Getting Started

1. Connect to mains supply.

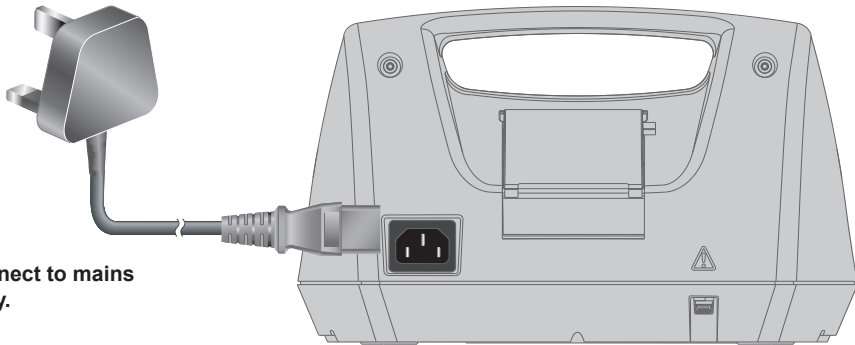

2. Press



3. Connect colour coded tubing



Note

Use the function buttons below the display to access and change the system setting and patient measurement menus.

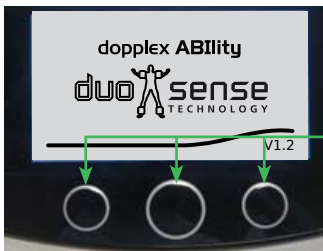

Function Buttons



12.2 Loading Paper *

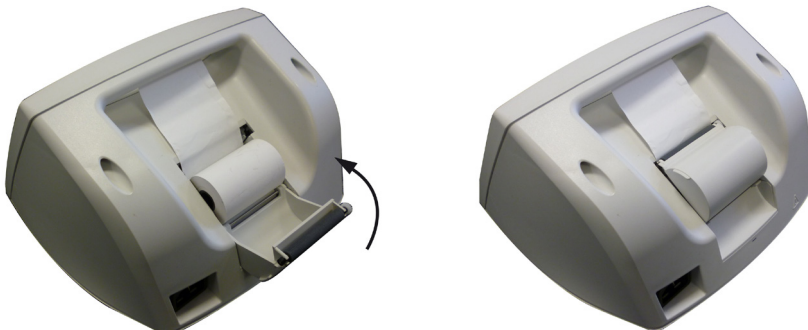

1. Grasp printer door firmly and pull gently backwards.
2. Insert paper roll as shown and close printer door. A 'click' will be heard when door is fully engaged.
3. To tear paper, hold firmly and tear from one edge towards the front of the unit.

Note:

- If using label paper, ensure roll ends are smooth. If not, press end of roll onto a flat surface
- The printer lid is designed to detach if forced. To replace, hook the two lid pivots over the metal rod and press firmly downwards. A positive 'click' will be heard as each pivot snaps into place.
- Standard (Plain) paper will allow approximately 55 printouts.
- Label paper will allow approximately 35 printouts.

CAUTION

Only use paper approved by Huntleigh.

12.3 User Settings

12.3.1 System Settings

CAUTION

Do not apply excessive pressure to the buttons, or use a sharp implement, such as a pen to press the buttons, as damage may result.

1. Press  to access the system settings.

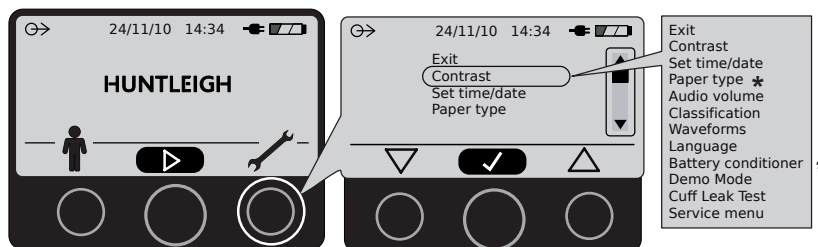

* Depending on model



2. Press to scroll through the setting menus. Press to select.

a. Contrast: Press to set Contrast value. Press to Confirm.

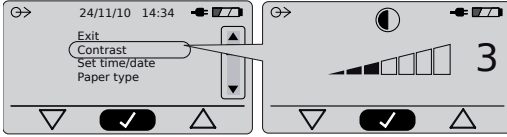

b. Time/Date: Press to Confirm. Press to set Time.

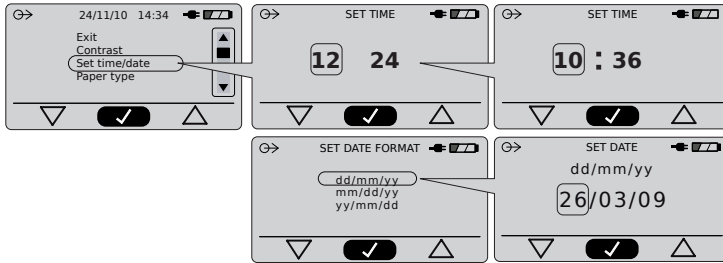

Press to set Date format. Press to Confirm. Press to set Date.

Note

As the Time and Date are printed on the printout, the time and date must be set correctly.

c. Paper Type: * Press to select Paper type. Press to Confirm.

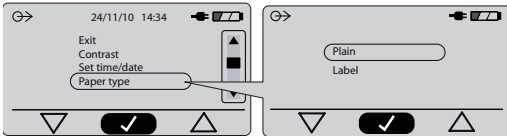

Note

"Label" type is the adhesive backed thermal label paper (see Section 16.6)

d. Audio Volume: Press to select required volume. Press to Confirm.

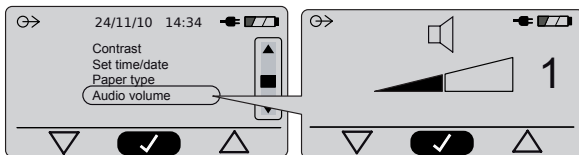

e. Classification: Press ∇/Δ to select Classification ON or OFF. Press \checkmark to Confirm.
 Press ∇/Δ to change thresholds. Press \checkmark to Confirm.

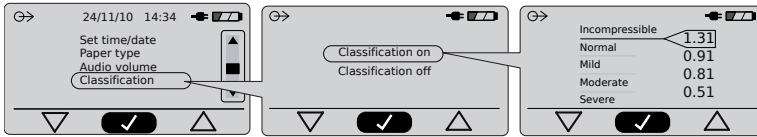

CAUTION

The ABI Classification thresholds, which are adjustable via the front panel function buttons, should only be adjusted by a suitably qualified clinician.

f. PVR Waveforms: Press ∇/Δ to select Waveforms ON or OFF. Press \checkmark to Confirm.

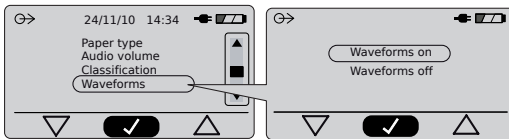

g. Language: Press ∇/Δ to select required Language. Press \checkmark to Confirm.



h. Battery Conditioner: * Press ∇/Δ to select Battery Conditioner. Press \checkmark to Confirm.

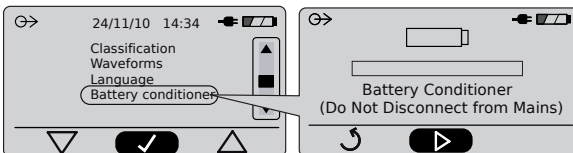

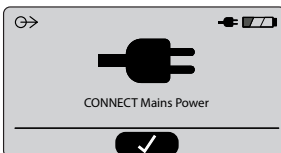

If Battery Conditioner is selected when mains (line) power is not connected, the following message is displayed:-





Note: Battery conditioning will take approximately 8-10 hours to complete.

** Depending on model*

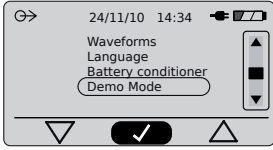
i. **Demo Mode:** Press   to select Demo Mode. The Demo Mode shows results that have been pre-stored in the Ability. This mode is useful at exhibitions without the need for a full test. The printout is clearly marked 'Demo Mode' and shows pre-stored results and artificial waveforms.



j. **Cuff Leak Test:** Refer to Troubleshooting Section.

k. **Service Menu:** Press   to select Service Menu. You will require a 4 digit access code to enter this function. Please see Service Manual for further details.

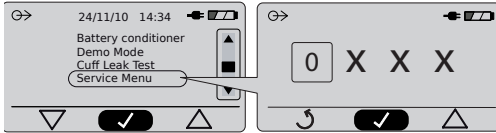

12.4 Making a Measurement

12.4.1 Patient Preparation



- **WARNING:** Before fitting cuffs to the patient, evaluate the cross contamination risk. For medium/high risk situations, where the patient has a known infection or skin is not intact, use an infection control barrier sleeve with aseptic technique.
- **WARNING:** Do not apply cuff directly to non-intact skin. If a wound is present, ensure a suitable wound dressing is applied, followed by an infection control barrier sleeve.

Fitting Infection Control Barrier Sleeves

Arm

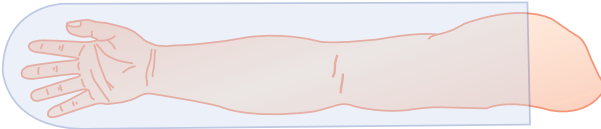

Leg

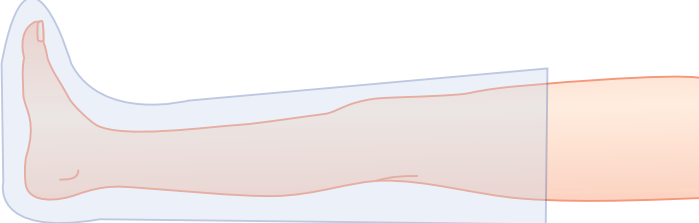





Note: Remove any trapped air before tightening cuffs.

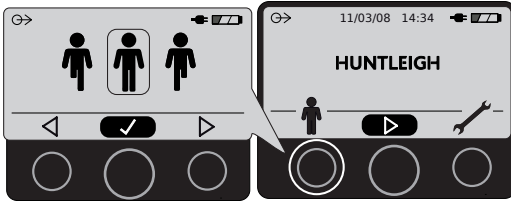

12.4.2 Setting Patient Type

1. Press  .



2. Press   to select patient normal or amputee mode. Press  to Confirm.

3. Press  to progress to cuff placement screen.

12.4.3 Fitting the Cuffs

1. Position the cuffs on the patient.

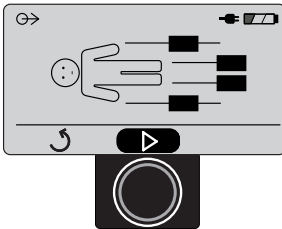

CAUTION: Ensure all cuffs are fitted correctly and aligned on limbs according to the instructions. Measurement error may occur if cuffs are fitted incorrectly.

Note: For clarity purposes, the following illustrations show limbs un-clothed. Cuffs can be fitted and measurements taken over thin clothing such as tights, thin shirts and thin socks. Cuffs cannot be fitted over jumpers or trousers.



Correct Cuff Placement



RED-
RIGHT ARM



YELLOW - LEFT
ARM

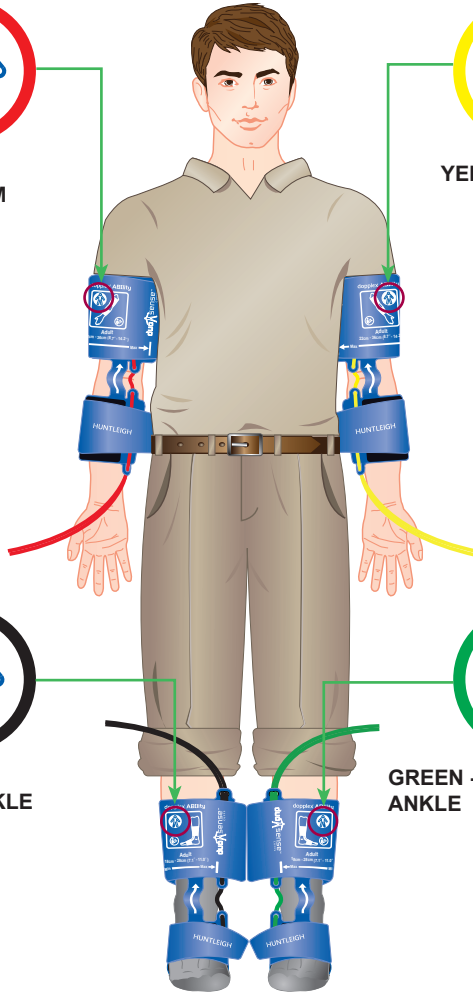

BLACK-
RIGHT ANKLE



GREEN - LEFT
ANKLE

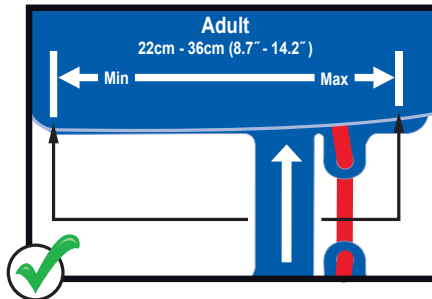



Arm

Infection Control Barrier Sleeve

Note: Remove any trapped air before tightening cuffs.

Place strap with white line over the inside of the arm (Over brachial artery)

Place distal chamber just below elbow, on largest diameter part of the forearm.

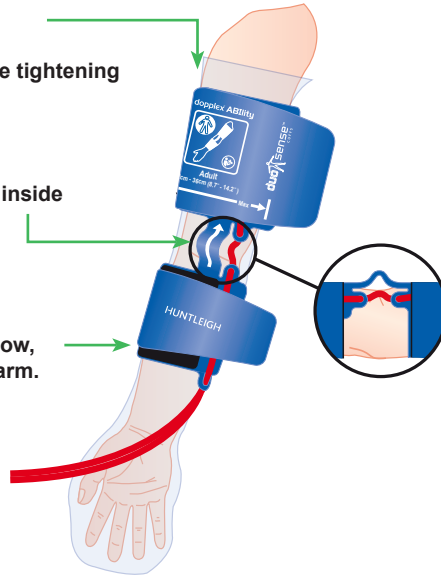

Leg/Foot

Infection Control Barrier Sleeve

Note: Remove any trapped air before tightening cuffs.

Ensure strap is fitted on top of the foot. (Over anterior tibial artery)



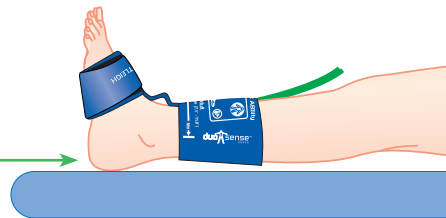

Foot Position

Ensure patients heel is resting on the couch. Do not rest the leg on the cuff as this may affect measurement result.

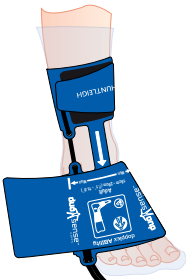

Incorrect Cuff Placement

		<p>Ensure the cuffs are not rotated around the limb.</p> <p>Measurement error or failure to take correct measurement may occur if cuffs are fitted incorrectly</p>
		<p>Ensure the cuffs are fitted in the correct orientation.</p> <p>Measurement error or failure to take correct measurement may occur if cuffs are fitted incorrectly</p>

Note

- Take great care to ensure that the tubing is not kinked or obstructed in any way. Do not touch cuffs or tubing when measurement is in progress.
- The patient must lie supine, be relaxed, remain still, and refrain from talking, coughing etc
- Always brief the patient before the test, explaining that the cuffs will tighten, and that the test will take approximately 3 minutes to complete.

12.4.4 Performing the test

Patient Briefing

The patient should always be briefed on what to expect during the test to avoid unnecessary distress. This should describe how the cuffs will inflate, and then after a short delay the arm cuffs will both tighten, followed by tightening of the ankle cuffs. After approximately three minutes all cuffs will deflate and the test will be complete.

They should be advised that the test can be stopped at any time if they find the test unbearable. This is done by pressing the centre key below the display.

The patient should also be asked to remain perfectly still during the test, and not to talk or cough etc.

1. Press  to start measurement.

CAUTION: Always remain with the patient and monitor test progress.

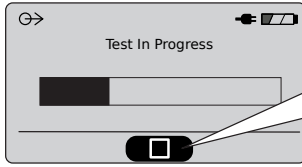

IMPORTANT!
Press  to stop the test at any time.

12.4.5 Viewing the results

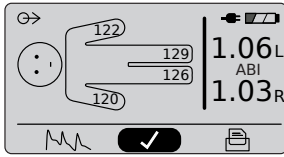

1. The results will be displayed within 3 minutes.



2. Press  to print results.*

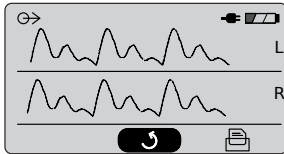

3. Press  to show PVR waveforms.

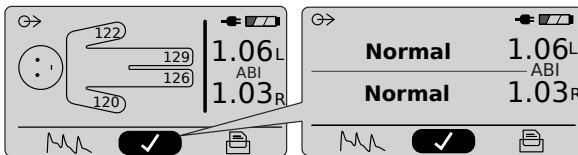

4. Press  to return to previous screen or  to print* PVR waveforms.

5. Press  to view the ABI Classification.



6. Press  to print* or  to start a new test.

CAUTION: Always observe ABI value, not only classification, as marginal results could be overlooked.

CAUTION: Systolic pressures are displayed for information only, and should not be used to form a clinical diagnosis.

* Depending on model



12.4.6 Example reports

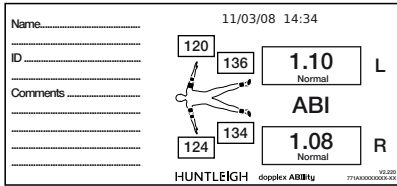
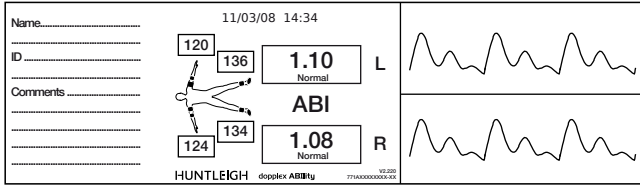

Note: Always annotate patient information on report.

12.4.7 Paper Low Indication *

When the paper approaches the end of the roll, a red marker line will be visible on the report. Approximately 5 reports with PVR or 8 reports without PVR can be printed before the paper runs out. If the print button is pressed when the paper has run out, the following message will be displayed:-

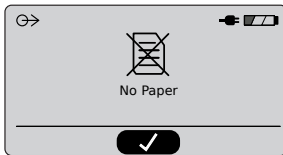

12.4.8 Report Storage Guidance *

Store in a cool dry place. Do not expose to sunlight, temperatures greater than 38° C, relative humidity over 80%, or place in contact with adhesives, adhesive tapes or plasticizers such as those found in all pvc page protectors.

It is recommended that reports are photocopied for optimum storage lifetime.

12.5 Switching the Unit into Standby



Press and hold button for approximately 3 seconds to switch the unit into Standby.

** Depending on model*

13. Troubleshooting

This section gives some of the more common problems encountered during use together with possible causes. If the problem cannot be located after consulting the table in this section, the dopplex Ability should be switched off, disconnected from mains power source and a qualified technician should be consulted.

Before attempting troubleshooting, verify that the power cable is properly connected to both the dopplex Ability and the mains power source.

SYMPTOM	POSSIBLE CAUSE / REMEDY
Green power indicator not illuminated	1. Power cable not connected to live power source 2. Defective power cable 3. Mains input fuses blown
Unit will not turn on	Connect to live power source
Printout blank *	Paper inserted incorrectly
Battery Low symbol showing *	Connect to the power source
Battery does not hold charge *	Select 'Battery Conditioner' menu (section 12.3.1) or replace battery
No results produced	Check all tubes and cuffs and repeat test.
Only one ankle cuff inflates	Check patient type is correctly set (See section 12.4)
Display not clear	Contrast setting is incorrect (See section 12.3.1)
Printout not clear on label paper *	Check setting of paper type (See section 12.3.1)
Paper printout jams *	Incorrect paper fitted
Unit will not fit to roll stand	Ensure mounting plate is fitted correctly
Cuff takes a long time to inflate	Check air filter or check cuffs for leaks

* Depending on model

13.1 Error Messages

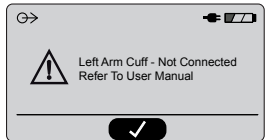
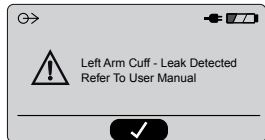
Cuff Not Connected	
<p>If the user fails to connect one or more of the cuffs to the unit or the cuffs are not tensioned correctly, one of the following messages is displayed:-</p> <ul style="list-style-type: none"> • Left / Right Arm Cuff - Not Connected • Left / Right Ankle Cuff - Not Connected • Arm Cuffs / Ankle Cuffs - Not Connected 	
<p>Recommended Action: Check that the cuffs are properly connected, and are fitted snugly. Refer to section 12.4.3.</p>	
Cuff Air Leak	
<p>If an air leak is detected in the cuffs or tubing, one of the following messages is displayed:-</p> <ul style="list-style-type: none"> • Left / Right Arm Cuff - Leak Detected • Left / Right Ankle Cuff - Leak Detected • Arm Cuffs / Ankle Cuffs - Leak Detected 	
<p>Recommended Action: Run the Cuff Leak test in Section 13.2.</p>	

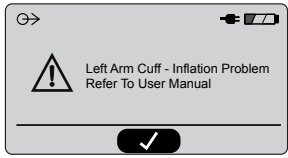
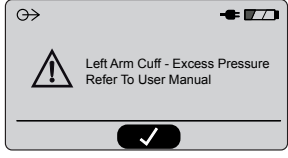
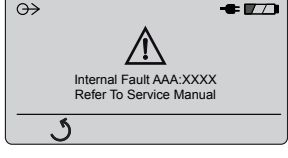
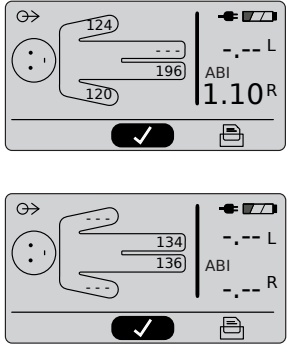
Inflation Problem	
<p>If any cuff fails to inflate correctly, one of the following messages is displayed:-</p> <ul style="list-style-type: none"> • Left / Right Arm Cuff - Inflation Problem • Left / Right Ankle Cuff - Inflation Problem • Arm Cuffs / Ankle Cuffs - Inflation Problem 	
<p>Recommended Action: Check cuffs are fitted correctly and tubing is not kinked or obstructed. If problem persists, refer to Service Manual for diagnostic test procedures.</p>	
Excess Pressure	
<p>If excess pressure is detected in any cuff, one of the following messages is displayed:-</p> <ul style="list-style-type: none"> • Left / Right Arm Cuff - Excess Pressure • Left / Right Ankle Cuff - Excess Pressure • Arm Cuffs / Ankle Cuffs - Excess Pressure 	
<p>Recommended Action: Ensure the cuffs are not obstructed and are free to inflate properly. Do not squeeze the cuffs during tests, or allow them to become trapped, e.g. against a wall or similar hard surface.</p>	
Internal Fault	
<p>If an internal fault is detected, the following message is displayed on the screen:-</p>	
<p>Recommended Action: The unit must be referred for servicing and/or repair. Refer to contact details at the rear of this manual.</p>	
Systolic Pressure Out of Measureable Range	
<p>If the pressure in an occlusion chamber is insufficient to completely occlude bloodflow, the systolic pressure value will be replaced by:-</p> <p style="text-align: center;">“ _ _ _ ”</p> <p>and the corresponding ABI value will be replaced by:</p> <p style="text-align: center;">“ _ . _ _ ”</p> <p>For the ankles, this indicates a possible incompressible artery, or that systolic pressure is greater than 205 mmHg.</p> <p>For the arms, this indicates that systolic pressure may be less than 80 mmHg, or greater than 230 mmHg.</p>	
<p>Recommended Action: Follow local clinical protocols for patient referral.</p>	



Unable to Calculate Systolic Pressure	
<p>If the software algorithms are unable to calculate a systolic pressure, the systolic value will be replaced by:</p> <p style="text-align: center;">“ ? ”</p> <p>and the corresponding ABI value will be replaced by:</p> <p style="text-align: center;">“ _ . _ - _ ”</p> <p>If this occurs on both ankles, the results display will be replaced by the “CANNOT MEASURE” screen.</p>	
<p>Recommended Action: A possible cause is patient movement or incorrectly fitted cuffs, so a repeat test can be performed after checking cuffs and asking the patient to remain as still as possible.</p> <p>Note: When performing repeat tests on the same patient, allow at least 5 minutes for stabilisation between tests.</p>	

13.2 Cuff Leak Test

The integral cuff leak test is able to test two cuffs at a time for leakage. Each pair of cuffs is connected to the ankle cuff connectors (black and green) on the unit. The arm cuff channels (red and yellow) are not used in this test.

Procedure:

1. Connect a pair of cuffs to the ankle cuff connectors (black & green) on the unit.
2. Open the cuffs and lay them flat on a suitable surface.
3. Connect the unit to a mains supply and switch on.
4. Select the Setup menu ().
5. Scroll down to Cuff Leak Test and press accept ().
6. Press accept () to begin the test.
7. The cuffs will be inflated to a test pressure, and then deflated. Do not touch the cuffs during the test .
8. The test result will be displayed as Pass or Fail for each ankle channel.
9. Repeat for the remaining pair of cuffs.



13.3 Guidance for Reliable Performance

To improve the reliability of the results, the following points should be noted:

- Mobile/smart phones etc, must be at least one metre away from the unit.
- The couch should be separated from adjacent walls etc. as pressure on the arms or cuffs must be avoided.
- Check that the clothing is not too thick. The cuffs can be applied over thin shirts and socks or tights. If in doubt, remove the socks.
- Always brief the patient before the test, explaining that the cuffs will tighten, and that the test will take approximately 3 minutes to complete.
- The patient's arms must be supported by the couch.
- The patient's arms must be completely relaxed during the test and not pulled tight against the body.
- The patient's heels must be supported on the couch and not be allowed to overhang the end.
- The cuffs must have the correct tension – a snug fit (taught but not tight).
- The arm sense chamber must be located just below the elbow on the largest diameter part of the forearm. The connecting strap between the two chambers should not be flat.
- The patient must lie supine, be relaxed, remain still, and refrain from talking, coughing etc.
- The operator must not talk to the patient – this always prompts responses from the patient.
- The operator must not touch the cuffs or knock the tubing during the test.
- When performing repeat tests on the same patient, allow at least 5 minutes for stabilisation between tests.

14. Care and Cleaning

14.1 General Care

All Huntleigh Products have been designed to withstand normal clinical use, however they can contain delicate components which should be handled and treated with care.

Periodically, and whenever the integrity of the system is in doubt, carry out a check of all functions as described in the relevant section of the IFU. If there are any defects to the housing contact Huntleigh or your distributor for repair or to order a replacement.



- Please ensure that you check with your facility's local infection control policy and medical equipment cleaning procedures.
- Observe warnings and guidance on cleaning fluid labelling regarding use and personal protective equipment (PPE).
- Do not use abrasive cloths or cleaners.
- Do not use automatic washers or autoclaves.
- Do not use Phenolic detergent based disinfectants, solutions containing cationic surfactants, ammonia based compounds or perfumes and antiseptic solutions.
- If detergent or disinfectant wipes are used ensure that excess solution is squeezed from the wipe prior to use.
- Always switch off Products and disconnect from the AC supply before cleaning and disinfecting.
- Do not allow any fluid to enter the products and do not immerse in any solution.
- Always wipe off disinfectant using a cloth dampened with clean water.

14.2 Cleaning and Disinfecting Cuffs and Tubing

Before fitting the cuffs to the patient, evaluate the cross-contamination risk according to the definitions in the tables below:





1. Low Risk

For low-risk situations, when infection control barrier sleeves are not used, clean and disinfect the cuffs & tubing after use following the instructions below:

Definition	Procedure
Normal use or low risk situations including patients with intact skin and no known infection.	<ol style="list-style-type: none"> 1. Clean with soft cloth and a mild, neutral detergent @ 40°C (104°F) 2. Disinfect using a 70% isopropyl alcohol wipe or chlorine releasing agent @ 1000ppm available chlorine 3. Wipe with a cloth dampened in clean water. 4. Completely dry with a clean lint-free cloth

2. Medium / High Risk

Definition	Procedure
The patient has a known infection, or skin is not intact.	Because of the nature of the cuff materials, effective cleaning and disinfection in high risk situations is not practical. Therefore, infection control barrier sleeves are recommended as an alternative, to prevent cuff contamination.

	Do not iron		Do not use phenol or phenol-derivative disinfectant.
	Do not dry clean		Do not tumble dry
Do not machine wash. Do not immerse tubeset in water.			

CAUTION

- Do not allow any fluid to enter the cuff tubing.
- Do not use alternative cleaning agents or methods as permanent damage is likely.
- Inspect cuffs after cleaning and prior to use.

Cuff Inspection:

All four cuffs should be regularly inspected. Examine the outer cuff surfaces for material damage, splitting, fraying etc. Make sure that labelling is clearly legible. Check the cuff tubing and connections for damage, splits etc. If in any doubt as to the condition, the cuff(s) should be replaced. In any case, cuffs should be replaced every two years.

14.3 Cleaning and Disinfecting the Ability Unit

Always keep the external surfaces clean and free of dirt and fluids using a clean dry cloth.

1. The unit can be wiped with a soft cloth dampened with a mild detergent solution in water. Avoid the electrical contacts, apertures and connectors.
2. Wipe any fluids from the surface of the product using a clean dry cloth.
3. Wipe with a cloth dampened in 70% Isopropyl Alcohol.
4. Completely dry with a clean, dry lint free cloth.

If the product becomes contaminated, follow the 'low risk' cleaning and disinfection instructions given above, but use a more concentrated chlorine agent at 10,000 ppm available chlorine.

 **Warning: Repeated and unnecessary use of concentrated solutions will result in damage to the product. Do not allow sodium hypochlorite solutions to come into contact with metal parts.**

15. Maintenance

It is recommended that the Ability unit and accessories are inspected and tested at least annually. Full details are included in the Service Manual which can be obtained from Huntleigh Healthcare Service Department, quoting the unit serial number (email: service@huntleigh-diagnostics.co.uk).

Suitable test equipment and a full range of spare parts are also available. Please refer to service manual for further information and part numbers.

 **Warning: Servicing cannot be performed while the unit is in use.**



16. Accessories

16.1 Carry bag

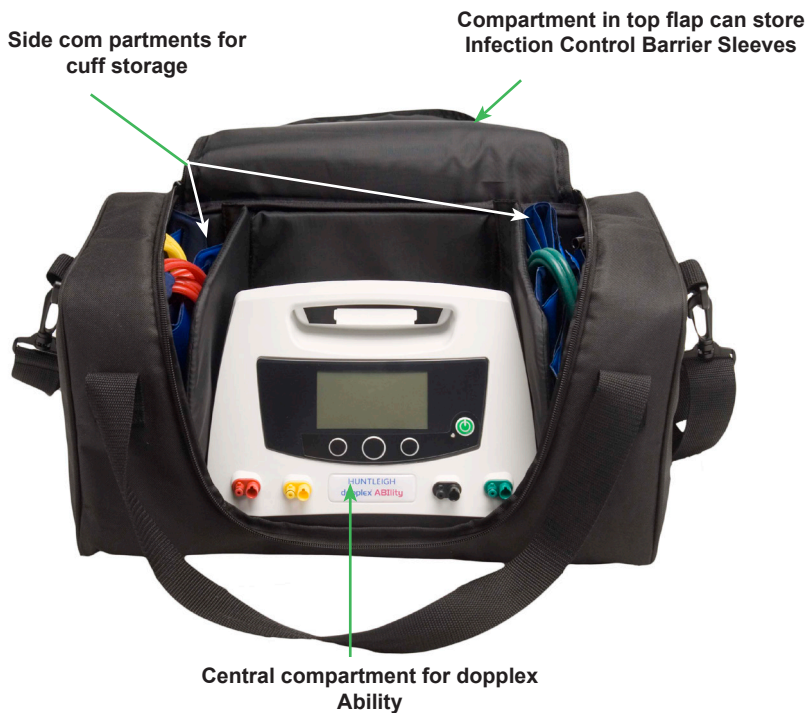

A carry bag is available for the dopplex Ability. It is highly recommended that the bag is always used whenever the unit is transported.

The bag includes a central compartment for the main unit. The side compartments each hold two cuffs. The cuff tubing must be wrapped around the cuffs neatly, before they are placed in the bag. This helps to keep the tubing and cuffs away from the zipper and avoids damaging them.

A shoulder strap is included for carrying comfort.

The bag includes a separate compartment at the rear for storing paperwork and infection control barrier sleeves.

To avoid damage to the mains cable, it should be unplugged from the unit.



16.2 Roll Stand

A roll stand is available which provides a stable means of support, and a convenient means of moving the unit around within the building.

Fitting the Ability Unit to the Roll Stand

The roll stand support incorporates a slide mount that allows the unit to be fitted and removed safely and quickly.

Note: To use the roll stand, a mounting plate (Part No ACC-VAS-012) is required to be fitted to the base of the Ability unit.

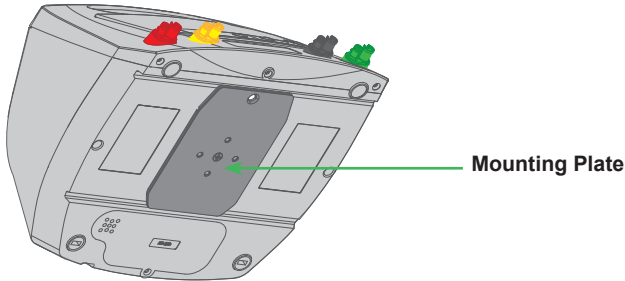

1. With the mounting plate fitted to the ability unit, slide the unit sideways ensuring that the plate is aligned with the grooves in the roll stand support surface.

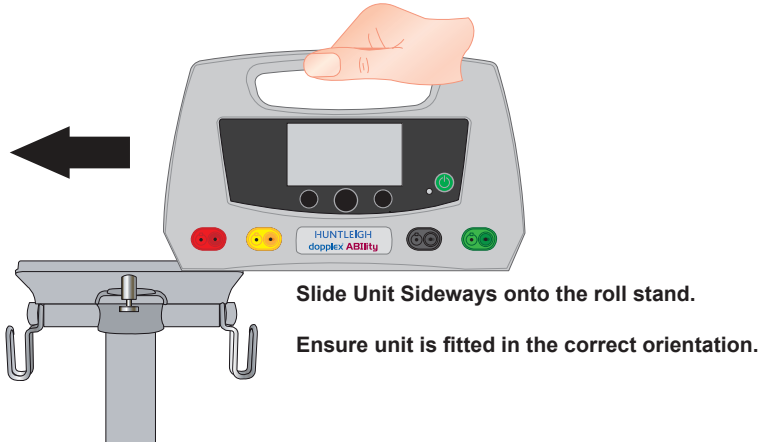



2. Locate the lock pin and pull downwards so that the Ability unit can be positioned centrally on the support surface.

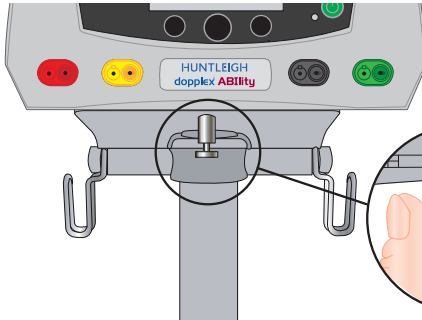

Pull lock pin downwards

3. Release the lock pin and ensure it locates in the hole in the mounting plate. This can be verified by attempting to slide the Ability unit sideways. **It must be securely locked into position.**

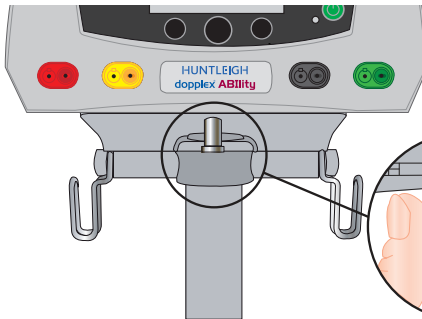

Release lock pin.

Ensure lock pin is properly engaged

CAUTION: Ensure that the Ability unit is securely fitted to the roll stand and that the lock pin is properly engaged.

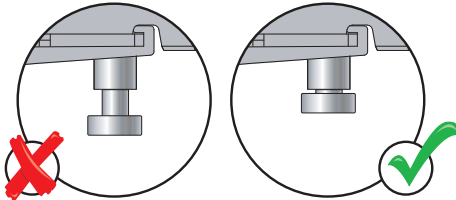

- **CAUTION:** Do not store other equipment in the basket.
- **CAUTION:** Ensure the tubing is securely supported before moving the roll stand.

Brakes

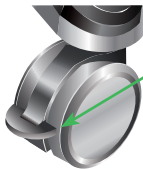



Three of the roll stand castors are fitted with brakes. Apply the brakes when the stand is stationary.



17. Specifications

17.1 Equipment Classification

Type of protection against electric shock.	Class II and Internally powered equipment with a functional earth terminal, which provides a ground path for the internal mains filter.	
Degree of protection against electric shock 	Type BF - equipment with an applied part.	
Mode of operation.	Continuous	
Degree of protection against harmful ingress of particles and/or water.	IP30	
Degree of safety of application in the presence of a flammable anaesthetic	Equipment not suitable for use in the presence of a FLAMMABLE ANAESTHETIC MIXTURE WITH AIR, OXYGEN OR NITROUS OXIDE	

17.2 Performance

Systolic Pressure Range	Arms : 80 - 220 mmHg Ankles : 55 - 205 mmHg
ABI	Doplex Ability provides valid ABI results for at least 80% of the patients tested. Valid results consist of both compressible vessels (where Doplex Ability agrees with the Doppler method to ± 0.28 for the 95% limits of agreement), and incompressible vessels.
PVR	Doplex Ability provides filtered PVR waveforms from the ankles with -3dB cut-off frequencies at 0.35 Hz and 10 Hz.
Maximum Cuff Pressure	230 mmHg

17.3 General

Supply voltage	100 to 240V ~ 50-60Hz.
Fuse Type	T1AH 250V
Power input	3-80 VA
USB	Connector : Mini Type: 1, full speed, 12 Mbps. Safety : Fully isolated
Printer *	Integral 58 mm, thermal
Paper *	Roll width : 58 mm nominal, Roll diameter : 40mm
Size	Height 160mm, Depth 240mm, Width 260mm
Weight	3Kg
Service Life	7 years

17.4 Environmental

Operating		Storage
10°C to 35°C	Temperature range	-20°C to 50°C
10% to 90% (non condensing)	Relative Humidity	10% to 90% (non condensing)
860mb to 1060mb	Atmospheric Pressure	860mb to 1060mb
Paper Shelf Life *	Up to 5 years if stored in the original wrapping in a dark place at an approximate relative humidity of 50% and a temperature below 25°C	

17.5 Standards Compliance

IEC 60601-1:2012	Medical Electrical Equipment Part 1 General Requirements for Safety
IEC60601-1-2:2014 [collateral standard]	General requirements for safety: Electromagnetic compatibility
ISO 10993-1:2018	Biological Evaluation of Medical Devices; Guidance on selection of tests
IEC 62366-1:2015	General requirements for basic safety and essential performance - Collateral standard: Usability
IEC 62304: 2006	Medical device software - Software life cycle processes.
IEC 15223-1: 2012	Symbols for use in the labelling of medical devices

17.6 Batteries

	Chemistry	Voltage	Compliance	Part No
Rechargeable Battery pack *	NiMH	12V	UL2054	SP-771332
Real time clock back up battery	Lithium Manganese Dioxide	3V	IEC60086-4	SP-771514

* Depending on model

17.7 Accessories

Item	Part No.
Roll Stand* with integrated storage basket and tube management (a)	ACC-VAS-013
Wall Mount with optional storage basket and tube management (b)	ACC-VSM-154
Utility Hook (for wall mount) (c)	ACC-VSM-187
Fixing plate** (d)	ACC-VAS-012
Carry Bag	ACC-VAS-015
Adult Cuff Set - arm and ankle cuffs	ACC-VAS-027
Adult Right Arm Cuff - 22 - 36cm	ACC-VAS-023
Adult Right Ankle Cuff - 18 - 28cm	ACC-VAS-024
Adult Left Arm Cuff - 22 - 36cm	ACC-VAS-025
Adult Left Ankle Cuff - 18 - 28cm	ACC-VAS-026
Large Adult Cuff Set - arm and ankle cuffs	ACC-VAS-011
Large Adult Right Arm Cuff - 34 - 46cm	ACC-VAS-007
Large Adult Right Ankle Cuff - 24 - 35cm	ACC-VAS-008
Large Adult Left Arm Cuff - 34 - 46cm	ACC-VAS-009
Large Adult Left Ankle Cuff - 24 - 35cm	ACC-VAS-010
Infection Control Barrier Sleeves (Disposable, box of 100)	ACC-VAS-016
Printer Paper	Standard Thermal Paper (Pack 5)
	Adhesive Backed Thermal Label Paper (Pack 5)
	ACC-VAS-017
	ACC-VAS-019

(a) + (d) - Items must be purchased together

(b) + (c) + (d) - Items must be purchased together



***Do not use dopplex Ability with other non-approved accessories.**



****Always use the Fixing plate when attaching the dopplex Ability to approved accessories.**

18. Electromagnetic Compatibility

Make sure the environment in which dopplex Ability is installed is not subject to strong sources of electromagnetic interference (e.g. radio transmitters, mobile phones).

This equipment generates and uses radio frequency energy. If not installed and used properly, in strict accordance with the manufacturer's instructions, it may cause or be subject to interference. Type-tested in a fully configured system, complies with IEC60601-1-2, the standard intended to provide reasonable protection against such interference. Whether the equipment causes interference may be determined by turning the equipment off and on. If it does cause or is affected by interference, one or more of the following measures may correct the interference:

- Reorienting the equipment
- Relocating the equipment with respect to the source of interference
- Moving the equipment away from the device with which it is interfering
- Plugging the equipment into a different outlet so that the devices are on different branch circuits



- **WARNING: The use of accessories, transducers and cables other than those specified, with the exception of transducers and cables sold by the manufacturer of the dopplex Ability as replacement parts for internal components, may result in increased emissions or decreased immunity of the dopplex Ability.**
- **WARNING: The dopplex Ability should not be used adjacent to or stacked with other equipment and that if adjacent or stacked use is necessary, the dopplex Ability should be observed to verify normal operation in the configuration in which it will be used .**

Guidance and Manufacturer's declaration - electromagnetic immunity			
The Dopplex Ability is intended for use in the electromagnetic environment specified below. The customer or the user of the Dopplex Ability should assure that it is used in such an environment.			
Immunity Test	IEC 60601 test level	Compliance level	Electromagnetic Environment - guidance
Electrostatic discharge (ESD) IEC 61000-4-2	± 8 kV contact ± 15 kV air	± 8 kV contact ± 15 kV air	Floors should be wood, concrete or ceramic tile. If floors are covered with synthetic material, the relative humidity should be at least 30%.
Electrical fast transient burst IEC 61000-4-4	± 2 kV for power supply lines ± 1 kV for input/output lines	± 2 kV for power supply lines ± 1 kV for input/output lines	Mains power quality should be that of a typical commercial or hospital environment.
Surge IEC 61000-4-5	± 1 kV line(s) to line(s) ± 2 kV line(s) to earth	± 1 kV line(s) to line(s) ± 2 kV line(s) to earth	Mains power quality should be that of a typical commercial or hospital environment.
Voltage dips, short interruptions and voltage variations on power supply input lines IEC 61000-4-11	<5 % U_r (>100 % dip in U_r) for 0,5 cycles 70 % U_r (30 % dip in U_r) for 25 cycles <5 % U_r (>100 % dip in U_r) for 5 s	<5 % U_r (>100% dip in U_r) for 0,5 cycles 70 % U_r (30 % dip in U_r) for 25 cycles <5 % U_r (>100 % dip in U_r) for 5 s	Mains power quality should be that of a typical commercial or hospital environment. If the user of the Dopplex Ability requires continued operation during power mains interruptions, it is recommended that the Dopplex Ability is powered from an uninterruptible power supply or battery.
Power frequency (50/60Hz) magnetic field IEC 61000-4-8	30 A/m	30 A/m	Power frequency magnetic fields should be at levels characteristic of a typical location in a typical commercial or hospital environment.
NOTE U_r is the a.c. mains voltage prior to the application of the test level.			

Instructions For Use

Guidance and Manufacturer's declaration - electromagnetic immunity

The dopplex Ability is intended for use in the electromagnetic environment specified below. The customer or the user of the dopplex Ability should assure that it is used in such an environment.

Immunity Test	IEC 60601 test level	Compliance level	Electromagnetic Environment - guidance
			Portable and mobile RF communications equipment should be used no closer to any part of the dopplex Ability, including cables, than the recommended separation distance calculated from the equation applicable to the frequency of the transmitter.
Conducted RF IEC 61000-4-6	3 Vrms 150kHz to 80MHz	3V	$d = 1.2 \sqrt{P}$
Radiated RF IEC 61000-4-3	3 V/m 80MHz to 2.7MHz	3V/m	$d = 1.2 \sqrt{P}$ 80MHz to 800MHz $d = 2.3 \sqrt{P}$ 800MHz to 2.7GHz
			<p>where P is the maximum output power rating of the transmitter in watts (W) according to the transmitter manufacturer and d is the recommended separation distance in metres (m). Field strengths from fixed RF transmitters, as determined by an electromagnetic site survey, ^a should be less than the compliance level in each frequency range ^b. Interference may occur in the vicinity of the equipment marked with the following symbol:</p> 

NOTE 1 At 80MHz and 800MHz, the higher frequency range applies.
 NOTE 2 These guidelines may not apply in all situations. Electromagnetic propagation is affected by absorption and reflection from structures, objects and people.

^a Field strengths from fixed transmitters, such as base stations for radio (cellular/cordless) telephones and land mobile radios, amateur radio, AM and FM radio broadcast and TV broadcast cannot be predicted theoretically with accuracy. To assess the electromagnetic environment due to fixed RF transmitters, an electromagnetic site survey should be considered. If the measured field strength in the location in which the dopplex Ability is used exceeds the applicable RF compliance level above, the dopplex Ability should be observed to verify normal operation. If abnormal performance is observed, additional measures may be necessary, such as re-orienting or relocating the dopplex Ability.

^b Over the frequency range 150kHz to 80kHz, field strengths should be less than 3V/m.

Guidance and Manufacturer's declaration - electromagnetic emissions		
The dopplex Ability is intended for use in the electromagnetic environment specified below. The customer or the user of the dopplex Ability should assure that it is used in such an environment.		
Emissions Test	Compliance	Electromagnetic Environment - guidance
RF emissions CISPR 11	Group 1	The dopplex Ability uses RF energy only for its internal function. Therefore, its RF emissions are very low and are not likely to cause any interference in nearby electronic equipment.
RF emissions CISPR 11	Class A	The dopplex Ability is suitable for use in all establishments, including domestic establishments and those directly connected to the public low-voltage power supply network that supplies buildings used for domestic purposes.
Harmonic emissions IEC 61000-3-2	N/A	
Voltage fluctuations / flicker emissions IEC 61000-3-3	Complies	

Recommended separation distances between portable and mobile RF communications equipment and the dopplex Ability			
The dopplex Ability is intended for use in an electromagnetic environment in which radiated RF disturbances are controlled. The customer or user of the dopplex Ability can help prevent electromagnetic interference by maintaining a minimum distance between portable and mobile RF communications equipment (transmitters) and the dopplex Ability as recommended below, according to the maximum output power of the communications equipment.			
Rated maximum output power of transmitter W	Separation distance according to frequency of transmitter m		
	150kHz to 80MHz	80MHz to 800MHz	800MHz to 2.7GHz
	$d = 1.2 \sqrt{P}$	$d = 1.2 \sqrt{P}$	$d = 2.3 \sqrt{P}$
0.01	0.12	0.12	0.23
0.1	0.38	0.38	0.73
1	1.2	1.2	2.3
10	3.8	3.8	7.3
100	12	12	23
For transmitters rated at a maximum output power not listed above, the recommended separation distance d in metres (m) can be estimated using the equation applicable to the frequency of the transmitter, where P is the maximum output power rating of the transmitter in watts (W) according to the transmitter manufacturer. NOTE 1 At 80MHz and 800MHz, the separation distance for the higher frequency range applies. NOTE 2 These guidelines may not apply in all situations. Electromagnetic propagation is affected by absorption and reflection from structures, objects and people.			

18.1 Electrostatic Discharge

Electrostatic discharge (ESD) is a known problem that can affect electrical equipment. If the dopplex Ability is subjected to ESD during an ABI measurement, it is possible that the measurement will be suspended. The air in all cuff chambers will be rapidly exhausted, and the unit will reset to the start-up screen.

If this happens, simply perform the usual checks and repeat the test.

19. End of Life Disposal

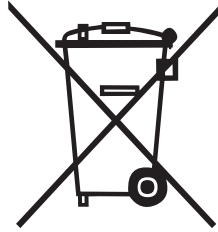

This symbol signifies that this product, including its accessories and consumables is subject to the WEEE (Waste Electrical and Electronic Equipment) regulations and should be disposed of responsibly in accordance with local procedures.

20. Warranty & Service

Huntleigh Healthcare Diagnostic Products Division standard terms and conditions apply to all sales. A copy is available on request. These contain full details of warranty terms and do not limit the statutory rights of the consumer.

Service Returns

If for any reason the dopplex Ability has to be returned, please:

- Clean the product following the instructions in this manual.
- Pack it in suitable packing.
- Attach a decontamination certificate (or other statement declaring that the product has been cleaned) to the outside of the package.
- Mark the package 'Service Department '

For further details, refer to NHS document HSG(93)26 (UK only).

Huntleigh Healthcare Ltd reserve the right to return product that does not contain a decontamination certificate.

Service Department.
Huntleigh Healthcare, Diagnostic Products Division,
35, Portmanmoor Rd.,
Cardiff. CF24 5HN
United Kingdom.

Tel: +44 (0)29 20485885
Fax: +44 (0)29 20492520
Email: sales@huntleigh-diagnostics.co.uk
service@huntleigh-diagnostics.co.uk

www.huntleigh-diagnostics.com



This section is only applicable to United Kingdom (UK) market when UK marking is applied to the Arjo medical device labelling.

UK Symbol:

	<p>UK marking indicating conformity with UK Medical Devices Regulations 2002 (SI 2002 No 618, as amended) Figures indicate UK Approval Body supervision.</p>
---	--

UK Responsible Person & UK Importer:

Arjo (UK) Ltd., ArjoHuntleigh House, Houghton Regis. LU5 5XF

Is the appointed UK Responsible Person as defined in UK Medical Devices Regulations 2002 (SI 2002 No 618, as amended).

For Northern Ireland (NI) CE marking will still apply until further amendment to applicable regulations.

1001071-2

Dopplex, Ability and Huntleigh are registered trademarks of Huntleigh Technology Ltd. 2011.





If a serious incident occurs in relation to this medical device, affecting the user, or the patient then the user or patient should report the serious incident to the medical device manufacturer or the distributor.
In the European Union, the user should also report the serious incident to the Competent Authority in the member state where they are located.

Manufactured in the UK by Huntleigh Healthcare Ltd on behalf of;



ArjoHuntleigh AB
Hans Michelsensgatan 10
211 20 Malmö, Sweden



2797

Huntleigh Healthcare Ltd.

35 Portmanmoor Road, Cardiff, CF24 5HN, United Kingdom
T: +44 (0)29 20485885 sales@huntleigh-diagnostics.co.uk
www.huntleigh-diagnostics.com

Registered No: 942245 England & Wales. Registered Office:
ArjoHuntleigh House, Houghton Hall Business Park, Houghton Regis, Bedfordshire, LU5 5XF
©Huntleigh Healthcare Limited 2011

A Member of the Arjo Family

As our policy is one of continuous improvement, we reserve the right to modify designs without prior notice.



www.huntleigh-diagnostics.com/



www.huntleigh-healthcare.us/

HUNTLEIGH

1001048-4

